

BOWDENS

SIGMA

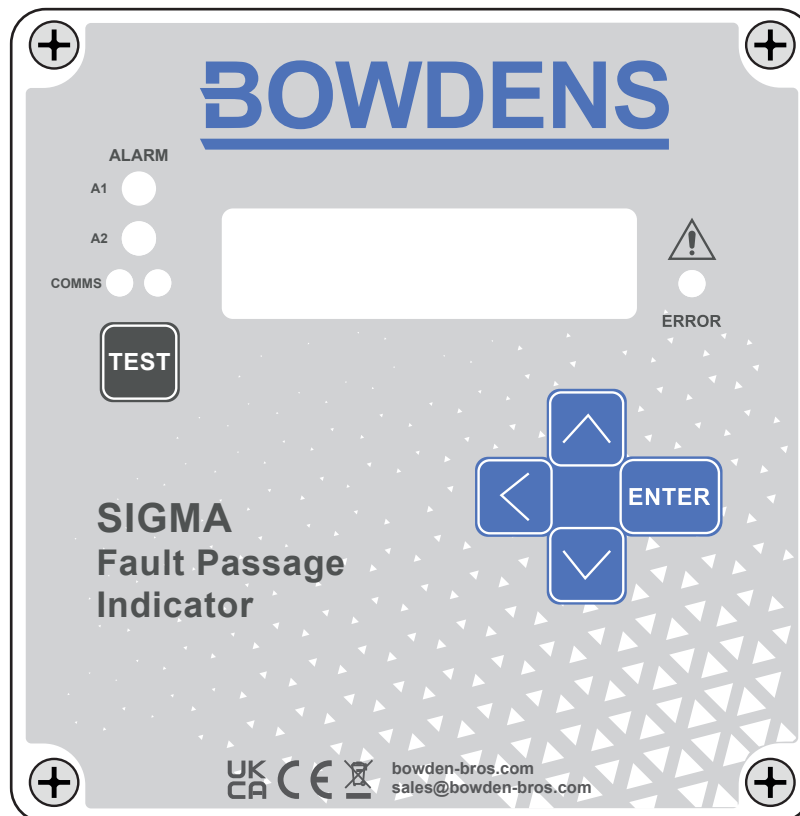

AN ADVANCED PROGRAMMABLE FAULT INDICATOR FOR UNDER-GROUND CABLE NETWORKS - Earth Fault Indicator with 4G Communications Option.

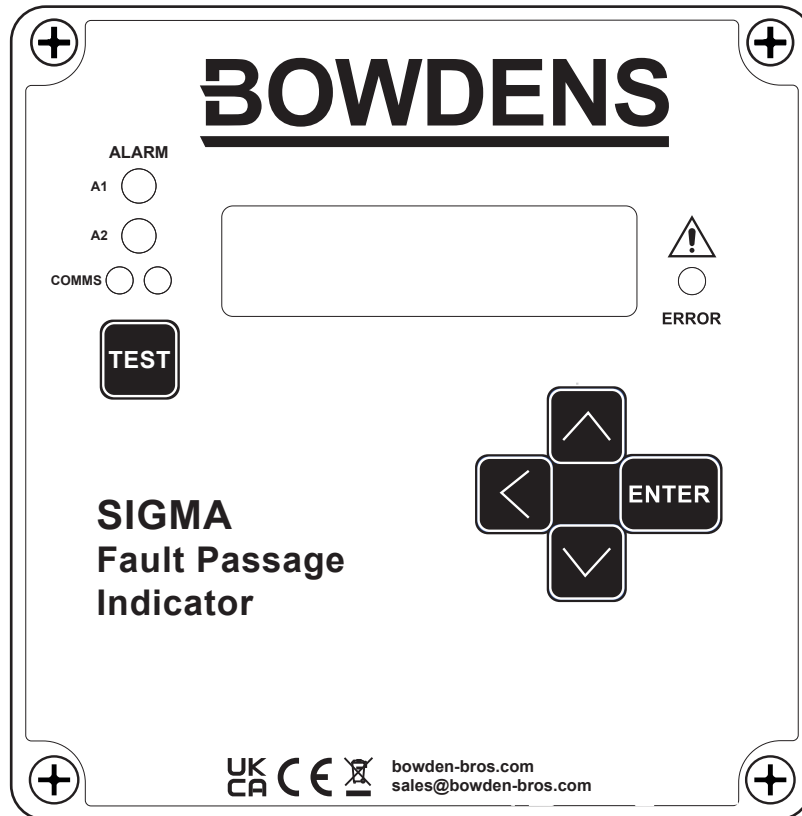

1.0 OVERVIEW

Bowdens have been influential in the design of the Electronic Earth Fault Indicator (EEFI) since the company first introduced this type of indicator in 1991. It now has a wide and proven range of earth fault indicators for fault indication on 11kV cable networks. The SIGMA fault indicator is an exciting development from this highly successful range of instruments to meet the demand of low cost instrumentation with minimal 'life time' costs.

The SIGMA fault indicator is a modular designed instrument that provides many options to the user as to the required features. From one basic module, options can be added to make a full overcurrent & earth fault indicator with integral 4G communication with individual phase load monitoring and historic log. However, the SIGMA is simply an earth fault indicator that will provide a clear visual indication of the passage of fault current and assist engineers to locate a faulted section of network on an Open Ring circuit. The faulted section of cable lies between the last fault indicator to Alarm and the first not to Alarm.

SIGMA is designed to compliment network automation and management giving greater visibility of network faults, enabling the fault engineer to isolate a fault intelligently, without the need for fault switching to locate a fault, with the inherent customer interruptions and excessive stress on plant and equipment.

The SIGMA module consists of a polycarbonate enclosure, which has a seal rating of IP65 giving a high level of environmental protection. The front of the enclosure displays two high intensity 'ALARM' LED's and two Comms LEDs. There is also a Test Button and four Menu Control buttons that enables the end user access to all function settings. An LCD display gives a visual display of all functions and data.

The SIGMA can be configured either as a single channel Earth Fault indicator (EFI), requiring one core balanced Current Transformer to drive the input, or as a 4 channel Overcurrent and Earth Fault indicator (OC/EFI), requiring three single phase C/Ts.

The SIGMA Earth Fault Indicator with a Core Balance C/T can be fitted around the MV power cable externally to the MV switch cable box or internally within the cable box, so long as appropriate station earthing arrangements apply. (See Drawing 1)

The SIGMA is tested beyond normal IEC levels to ensure reliable operation in the hostile electromagnetic and electrostatic environment in which it functions in. This includes testing of the communications functions, which must also perform within the same environment.

2.0 OPERATION

The SIGMA fault indicator can be programmed for many functions, via an LCD display and standard four arrow pad. Access to the programming feature is by PIN Code at one or more levels of security, which will allow the unit to be programmed by an engineer in the office. However, the Operating parameters can be pre-set at manufacture through an agreed 'Profile' which will contain all the settings required.

The flow chart overleaf gives the structure of the programming menu. In general terms the following actions are required to access the Menu:

The 'UP' button will power the LCD screen which will show the last event that occurred. This may be an Earth Fault or Phase Fault or a RESET with time and date.

If the SIGMA is powered from an LV source, then the display will then roll onto the Load Monitoring screen, which will display the load on each phase, I^1 , I^2 , I^3 (if three C/Ts are used) or the summated out of balance load I^4 in real time. It will also indicate if the LV power supply to the SIGMA is On or Off. This feature is not available for battery powered units.

To access the Menu press 'Enter' which will request a PIN Code. The access code will be a 5 digit number made up from the 4 clock face numbers 0 (at 12.00) 3, 6, and 9. The default setting number is 99999.

SIGMA PROGRAMMING MENU

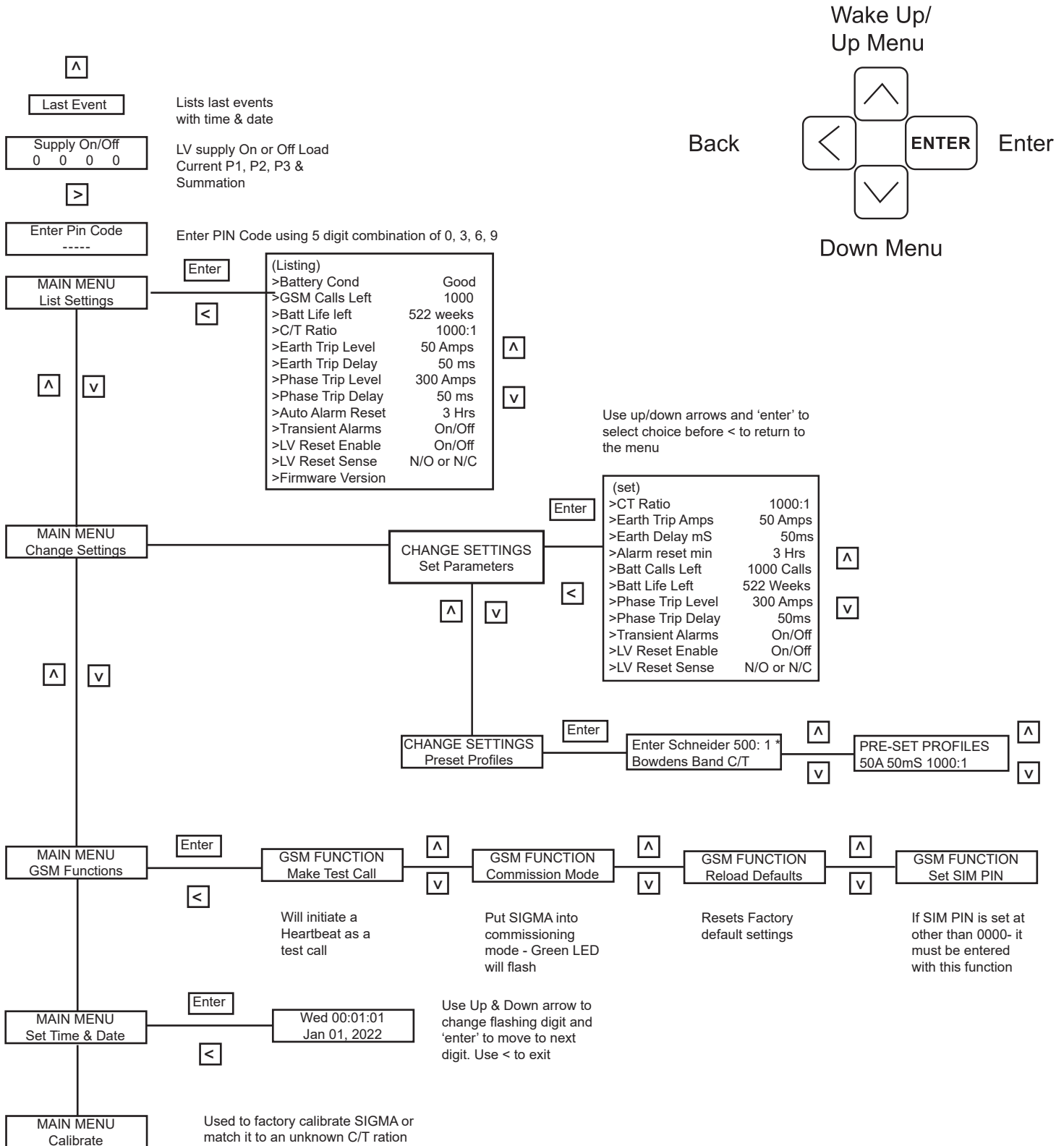

2.1 LCD DISPLAY

The default LCD screen displays the Alarm Status. The left arrow and enter takes you to the Main Menu from which you can choose to 'LIST' or to 'CHANGE' settings.

The features that can be listed or changed are:

Battery Condition - Based on a percentage usage when compared to a known average usage.

GSM Calls Left - The number of GSM calls remaining.

Batt Life Left - The number of weeks of power in the battery remaining.

C/T Ratio - Can be listed and set for ratios from 50:1 to 1000:1 to match the C/T that is supplying the input to SIGMA.

Earth Trip Level - The current level at which SIGMA will just trip. Optional from 10 to 100 Amps for EFI or 100 to 1000 Amps for OC/EFI.

Earth Trip Delay - The number of cycles required over which the fault current must exceed the threshold. Optional from 10 - 150mSecs. (This is the time window in which magnetising or capacitive current effects will be screened.)

Auto-Alarm Reset - The duration for which SIGMA will continue to alarm before it resets. Optional from 1 min to 24 hours.

Time & Date - A real time clock can be set, and will provide the time stamp for the historic log and for the communication.

Profiles - Standard profiles are available to be selected rather than setting all the parameters.

Firmware Version - The current software version installed.

2.2. SOFTWARE OPERATION

2.2.1 Alert State

In the 'Alert' state the unit is ready and waiting to capture the next earth fault. There is no visual indication. The 'FAULT' LEDs are de-energised. The Alarm Relay contacts are in the 'no fault' position.

2.2.2 Alarm State

In the 'Alarm' state the unit has captured an earth or over current fault. There are two high intensity red 'FAULT' LEDs, marked A1 and A2, that will give short flashes alternately every second. The Alarm Relay contacts are now in the fault or alarm position, and a Comms signal (if fitted) will be sent to indicate the alarm state. The unit is now power-save mode with the LED's flashing, until it receives a reset from either 1 min/24hr programmable timer, remote reset, LV reset or manual operation of the RESET switch. Any one of these resets will return the unit to the 'Alert' state, and will initiate a RESET GSM message.

2.2.3 Alarm Manual Test

Press the Test button on the front face of SIGMA, the two ALARM LEDs will flash alternately every second and the LCD screen shows 'Testing unit, EFI Alarm'. Press the Test Button

again to RESET. The flashing LEDs will reset, and message on LCD screen will read – ‘EFI ALARM – RESETTING ALARM’ followed by Comms messages ‘MANUAL RESET Call succeeded’, TEST BTN ALARM call succeeded. If left in the ALARM State SIGMA will RESET automatically after the programmed reset period. Pressing the Test/Reset button will initiate a GSM call for the alarm. A second press will initiate a reset GSM call.

2.2.4 Fault Detection

Once the unit has powered up and has entered the ‘Alert’ state it is ready to capture out of balance faults. EARTH FAULTS: When an earth fault occurs the fault current out of balance will be detected by the Current Transformer, so long as the circuit breaker or RMU earth has been brought back through the C/T to allow a positive flow of fault current through the C/T (Drawing 1). SIGMA uses a current/time graph to detect faults, which have to be above the threshold for a set number of cycles to identify the disturbance as fault current, rather than a spike or surge that could be caused by magnetizing or capacitive currents.

Over current and earth faults: A C/T monitors each individual phase to identify a current in any phase that is above the pre-set threshold for a given number of cycles, as well as the three phase currents being summated to give Earth fault current out of balance.

2.2.5 RESET CONDITIONS

Manual Reset

All SIGMA modules have Push Button Control reset. Push to reset the SIGMA to await the next event. This action will initiate a GSM message.

Timed Reset

The unit has a built in reset timer. This timer can be configured from between 1 min to 24 hours. Following completion of the selected reset time the unit will reset to the Alert State, and will initiate a 4G Reset message. To disable the timed reset continue to press the down arrow until the message “Auto Reset Off” is displayed.

Remote Reset

The unit can be configured for Remote Reset from an RTU Volt free relay contact. Connect relay contacts to short between -ve 0V and R on reset terminals - see connection diagram on P11. The twin LEDs will flash three times to indicate the reset state, and the reset message is shown on the LCD screen.

LV Reset

The SIGMA can only be reset with an LV supply if the units is supplied with the LV processing PCB.

2.2.6 Earth fault Indication

SIGMA will operate from either the Bowdens Band Sensor C/T (120mm id.) (see Drawing 3) or a Resin Cast Core Balance C/T (90mm id). It can be programmed to operate from most common ratios of Core Balance C/T types.

The C/T must detect the out of balance when installed around a three phase cable, either externally on the incoming cable to the RMU or circuit breaker, or internally in the cable termination box. In all cases it is important to observe the correct configuration of the station earth to ensure an out of balance can be seen during fault (see Drawing 1, Fig 6.1).

SIGMA may also be connected to the three bushing C/Ts in an RMU or Circuit breaker. In this configuration the C/T outputs must be commoned to give a single input to the SIGMA earth fault relay.

2.2.7 Overcurrent & Earth fault Indication

Not covered in this specification.

2.2.8 COMMUNICATIONS – 4G

In common with a number of Bowdens alarm products, SIGMA is offered with an integral communications package as an option. A 4G modem is included with internal or external antenna, to deliver the alarm or heartbeat data to an engineer’s mobile telephone, a P.C. Base Station or Server, or other compatible alarm monitoring software.

Install the SIM Card in the SIM card holder ensuring the card is the correct way around. If supplied with an external bulkhead connector, connect the magnetic mount antenna to the bulkhead connector on SIGMA. SIGMA will not receive a comms message if the antenna is not connected. Commissioning must be carried out using a SIM enabled for a public APN.

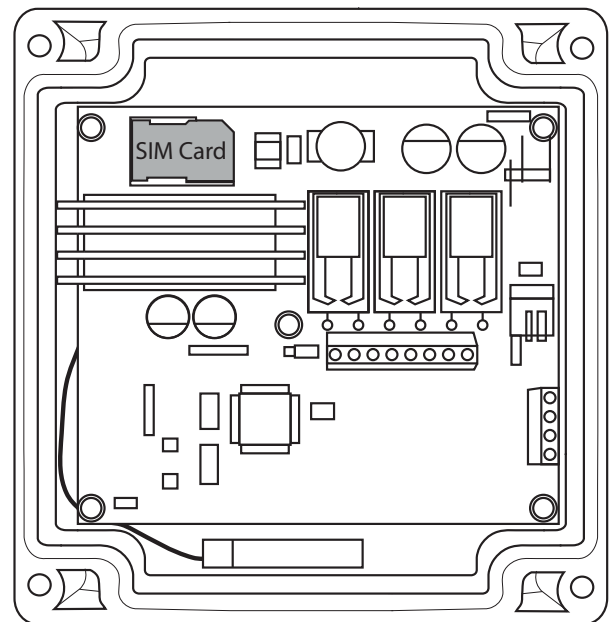

With the battery connected, use the UP/DOWN arrows to start SIGMA. Using the Enter button enter the PIN code and from the main menu select ‘GSM Functions’ and Enter. Select ‘Commission Mode’ and Enter, and observe the following display messages.



Select the GSM Function Menu and Enter. Follow the screens below (not all screens are shown)



If SIGMA does not progress beyond this message within about two minutes, it is likely the SIM card is not compatible with SMS message delivery.

At this point the green LED will be flashing, and the SIGMA is waiting for a commission message from our website (www.faultwatch.com)

2.2.9 COMMISSION WEBSITE

On the internet, go to the Bowden Bros Website at www.faultwatch.com and enter the username and password supplied to you to enter your account.

The opening page gives a selection of our products that can use this technology and the type of system used to receive the data (Mobile phone or Base Station), make the appropriate selection and submit.

Product Selection

Please select your instrument type and click Submit

Product Name	Mobile	BaseStation
Mk10 - GSM	<input type="radio"/>	<input type="radio"/>
	<input type="radio"/>	<input type="radio"/>
PowerWatch	<input type="radio"/>	<input type="radio"/>
Siama - GSM	<input checked="" type="radio"/>	<input type="radio"/>

[Help](#)

Submit

Bowdens

BOWDENS SIGMA Setup to Mobile

About your Sigma Unit

Unit's SIM card Telephone number:
(Begin +44 for UK and leave out first 0)

+447590448707

Give your unit an identity or location caption:

(Up to 17 alpha-numeric characters. Do not use '/' character)

161050

Where to Send Your Alert Messages

Mobile Telephone number:
(Begin +44 for UK and leave out first 0)

+447899664375

Second Mobile Telephone number:
(Leave empty if not required)

+447773241651

HealthCheck Reporting

How often do you require Sigma to report it's status?:

7-Days ▾

Select which Mobile(s) are to receive HealthCheck messages:

Main ▾

Sigma Unit Security

Sigma Unit's Access PIN CODE:

99999

[Help](#)

Send

Fill in the fields giving the telephone numbers in the +44 format, and select the frequency of the SIGMA reporting its status as a health check. When the data is entered and the SIGMA is in Commission Mode, waiting for incoming data, press the Send button.

The confirmation of the message being sent via SMS will show below, it should also confirm the number of credits remaining on your account. Each call is one credit.

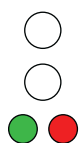

TEST

Processing
incoming message



When the SMS message is received by SIGMA it will light both LED's and start processing the data.

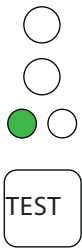

Signal 20<*****>
Connecting...



It will check the signal strength which must be above nine for an effective communications path.

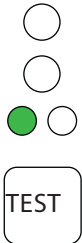

Sending SMS to
+440123456789



It will send a commission message to confirm to the receiving station, whether that be mobile phone or Base Station

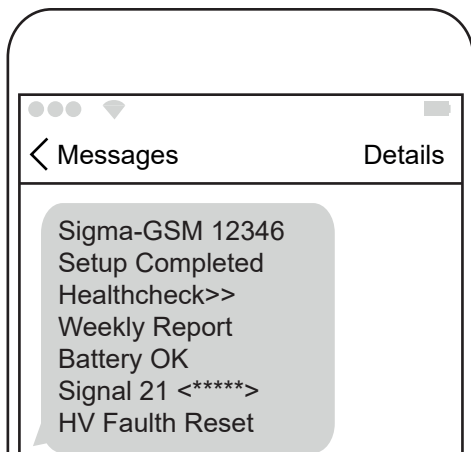

The Commission message will be displayed on the receiving mobile phone or on the Base Station Screen.

2.2.10 INSTALLATION

IMPORTANT - WARNING

1. The front section of the SIGMA module should never be drilled as this contains the module electronics.
2. All Current Transformers should be connected to the SIGMA module before being fitted in position round the cable.

SIGMA Module

Where practical SIGMA box drilling's for fixing should be through corner fillets, which are outside the sealed enclosure area. If this cannot be achieved holes can be drilled through the main enclosure walls providing the weatherproof IP65 box seal can be maintained. Alternatively, the SIGMA module can be mounted on a galvanised steel backplate. Please see 9.0 Mounting Data.

3.0 POWER SUPPLY

- Option 1. Sigma BAT. The unit is powered by a Lithium Thionyl Chloride 3.6V 13Ah integral Battery with up to 10 years life depending on operational usage and environmental temperatures.

- Option 2. Sigma LV. The unit includes a power supply board in the backbox. This allows the Sigma to be powered from LV mains at 230Vac. Note: the unit still requires a 3.6V 13Ah battery to be fitted.
- Option 3. Sigma RTU. The unit is powered by a 12V or 24V d.c. supply from an RTU

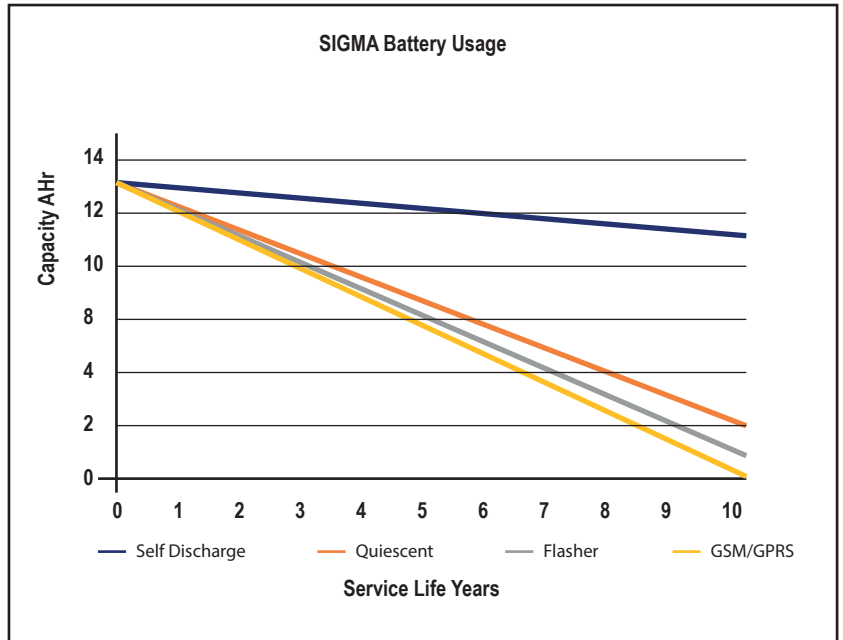

Battery Calculations based on:
 150 Flashing hours per year
 100 GSM/GPRS calls per year

4.0 CONNECTIONS

The example below shows an LV powered backbox with the Communication Option.

Fig 4.1

Note: Remove Black Plastic cover to make 230Vac LV mains connection

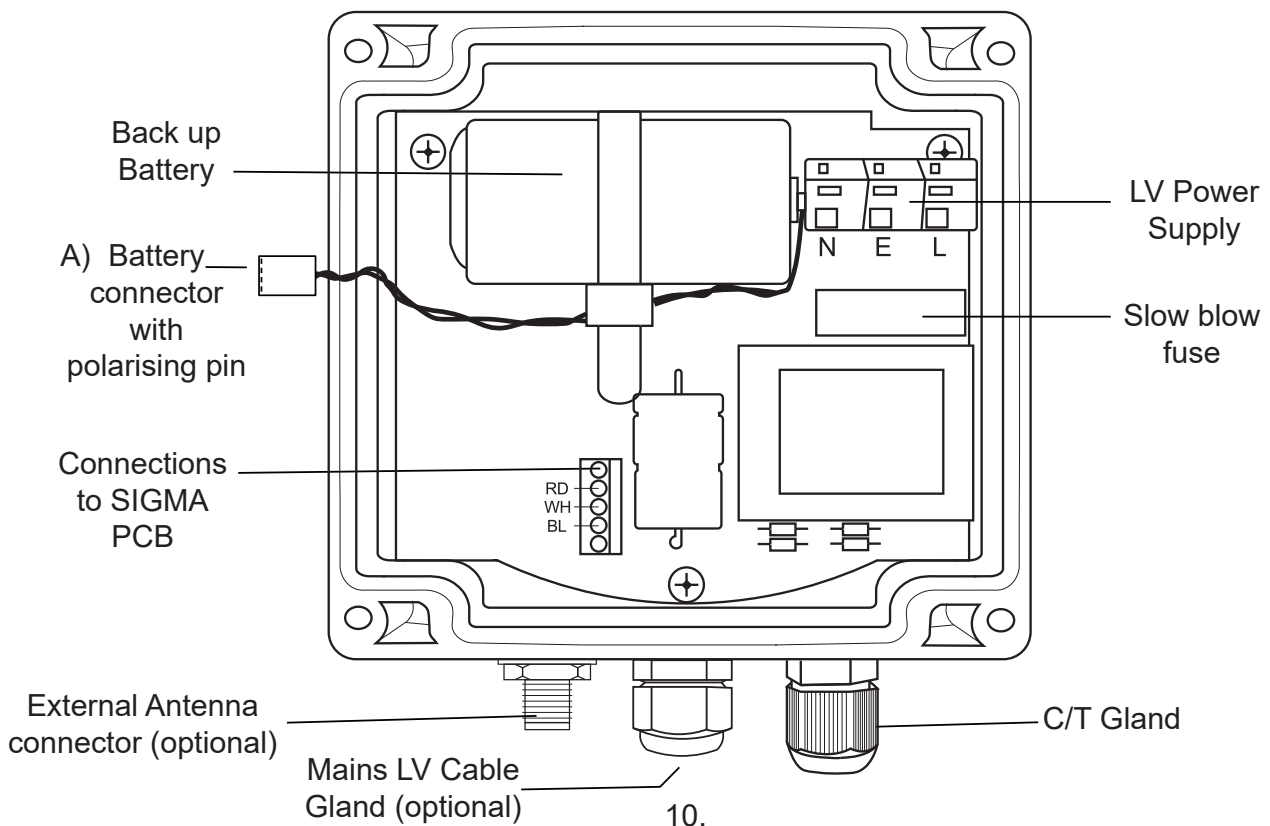

The example below shows an Battery powered backbox with the Communication Option.

Fig 4.2

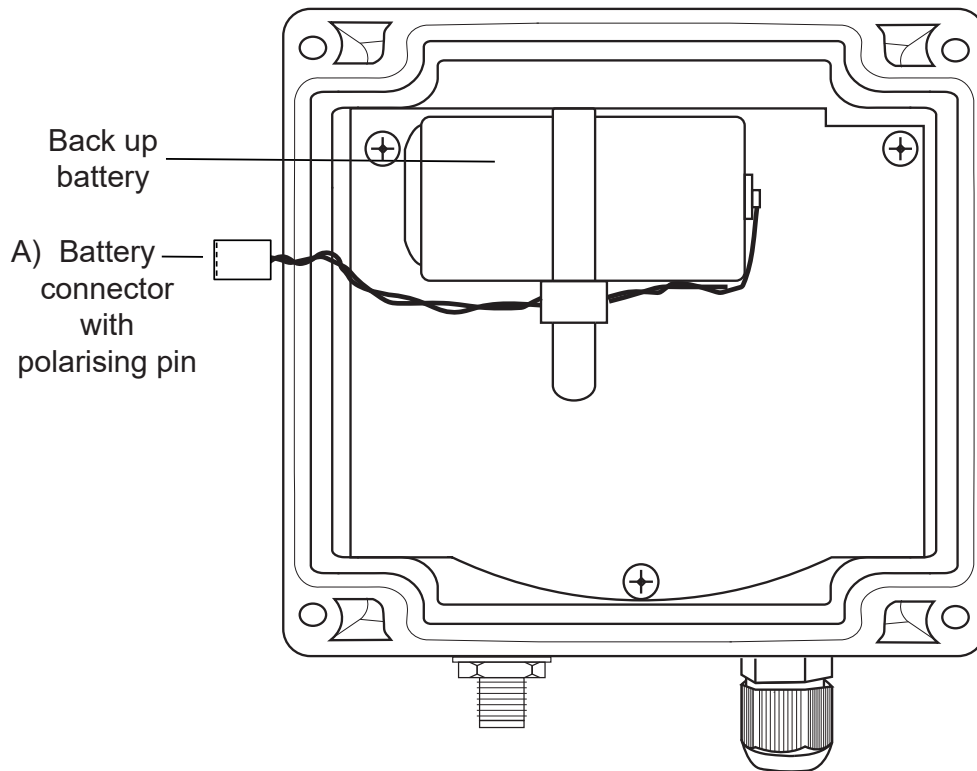

The example below shows an LV and Battery powered front panel.

Fig 4.3

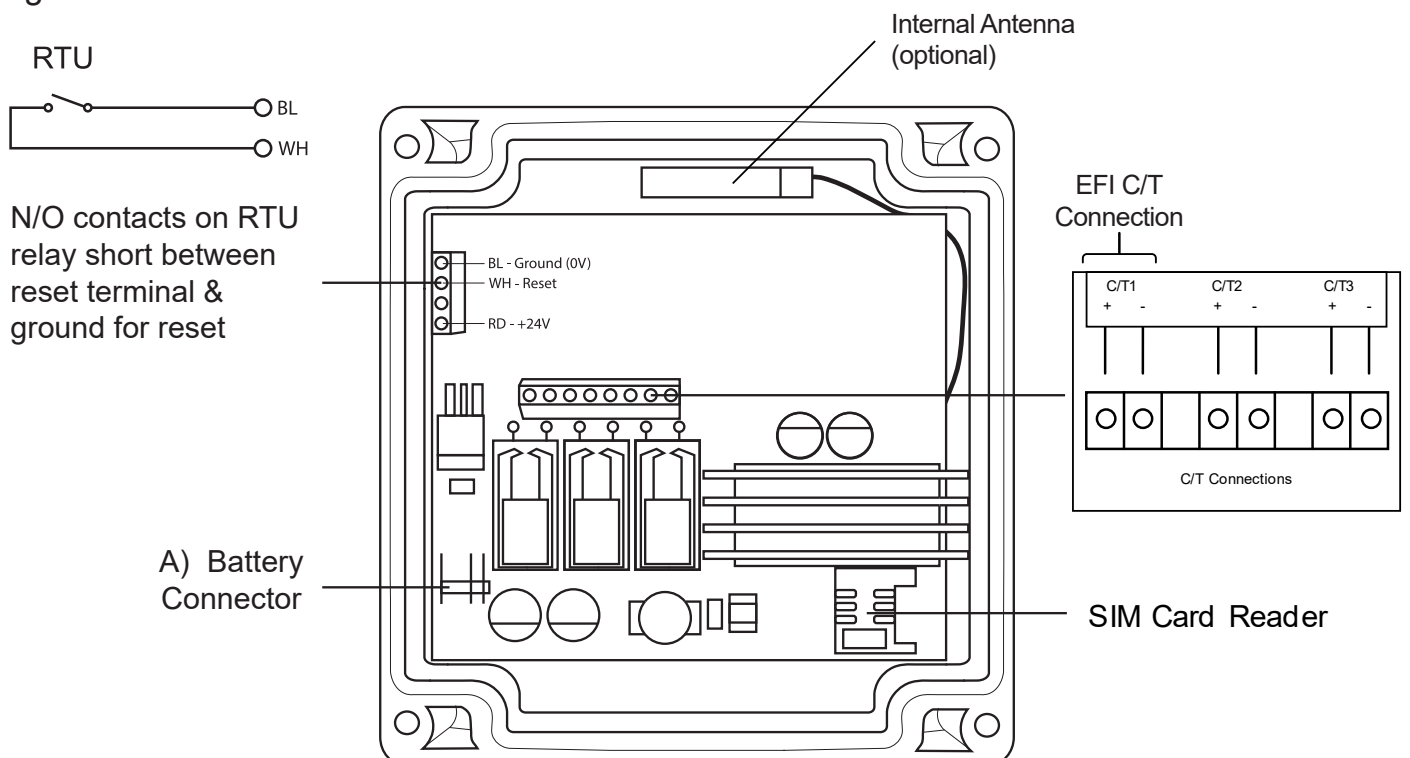

5.0 TESTING OF INSTALLATION

The following primary current tests prove the alarm functions and the Current Transformer input circuits.

Manual Testing

Available on all models with the Push Button Control. The twin LEDs will flash and a status 4G message will be initiated.

Primary Injection Testing

This test is applicable to all SIGMA models and can only be carried out if the SIGMA modules are connected to a Core Balance Current Transformer for earth fault testing or 3 x Phase C/Ts for over current testing. The test will confirm the correct operation of all modules and Band Current Transformer functions.

Sufficient primary current must be passed through the Current Transformer to cause the module to alarm. The SIGMA is set to operate at a fault current (e.g. 60A) above the user set current (e.g. 50A) threshold. Once triggered the module can either be left to reset automatically after its pre-set time out of 1 min/24 hours, reset manually or using the LV reset option. The primary current can be generated with a suitable a.c. current injection test set or with the Bowdens Portable EFI Tester.

LV Reset

Connect the 230/240V 50 Hz local reset supply to the terminals in the base of the SIGMA unit. If the SIGMA has tripped and the Volts lost from the local supply, as soon as the local supply returns for a period of 15 seconds the Sigma Alarm will be reset.

6.0 CURRENT TRANSFORMER INSTALLATION

SIGMA can operate with a Core Balance C/T for Earth Fault only indication or from 3 x Phase C/Ts for Overcurrent and Earth Fault Indication. Most C/T ratios can be accommodated via the C/T matching function in the program settings. The SIGMA is also designed to operate from the 1000:1 Bowdens Band C/T. Install the C/T according to Drawing 1 taking note of how the earthing should be applied to the C/T. Test the installation using Bowdens Portable EFI Tester - (see Section 4 - Testing).

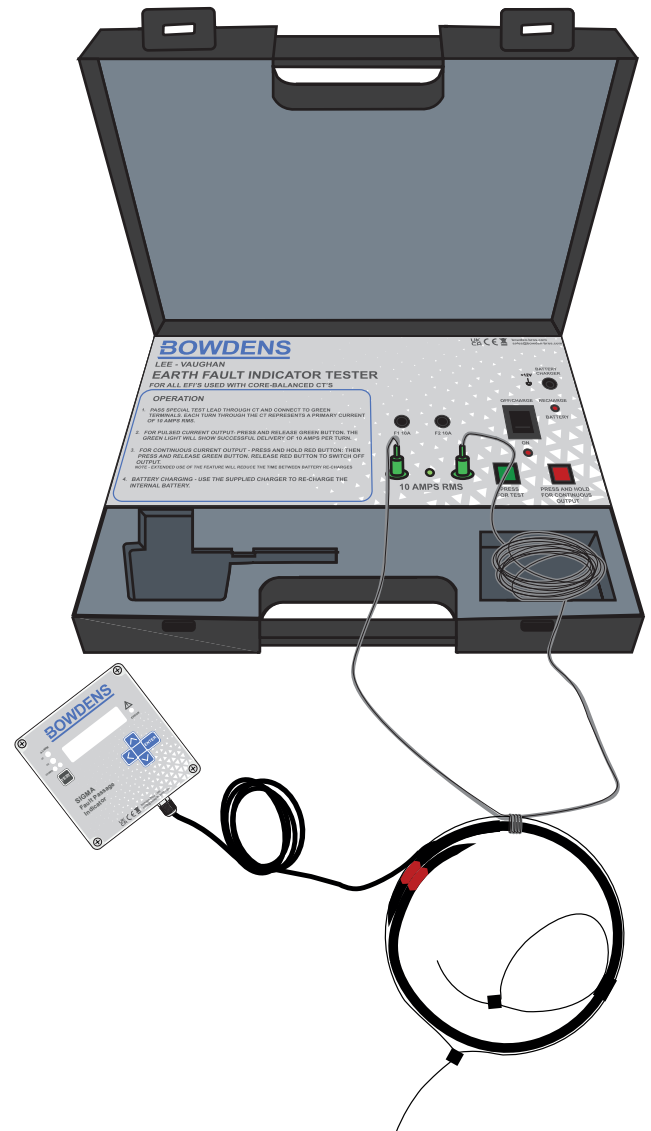

Drawing 1

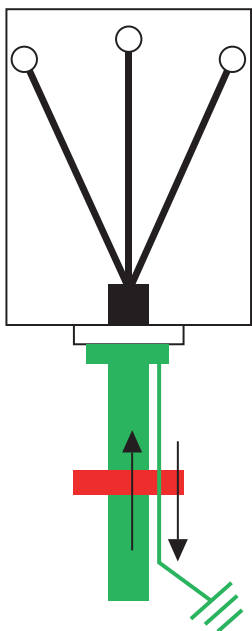

FIG 6.1

Traditional external cast resin C/T installation. Insulated gland at entry to cable box. An earth braid needs to be soldered to the earth termination and brought back through the C/T to cancel the earth fault flowing in the cable sheath.

FIG 6.2

Sheath earth terminates at insulated gland and so the C/T can be installed in the base of the cable box where it will detect only out of balance caused by earth fault flowing in one phase.

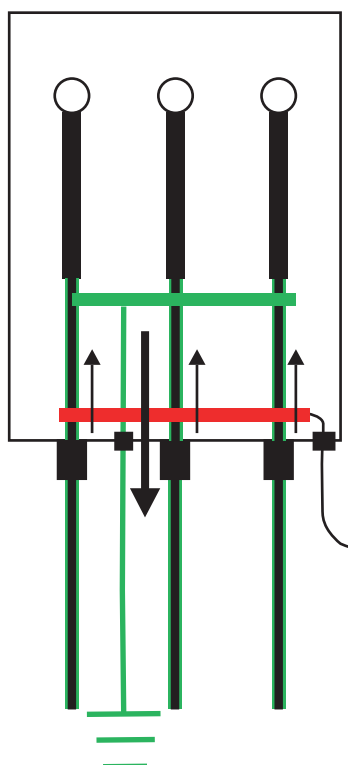
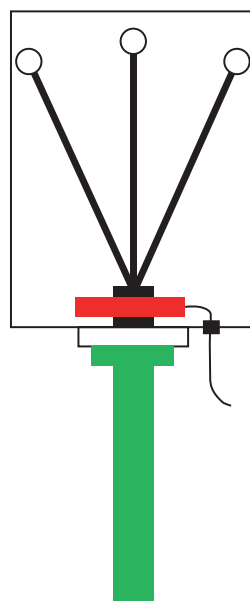

FIG 6.3

Individual phases enter cable termination box separately. A large diameter band type C/T can be placed in the base of the cable box to encompass all three phases. If the earth terminates above the C/T position then it must be collectively brought back through the C/T as shown.

FIG 6.4

Alternatively individual phase C/Ts may be installed, and summated in parallel for earth fault output, or as phase C/Ts for Over current and Earth Fault EFI. If the Earth terminates above the C/T position then it must be collectively brought back through the C/T as shown.

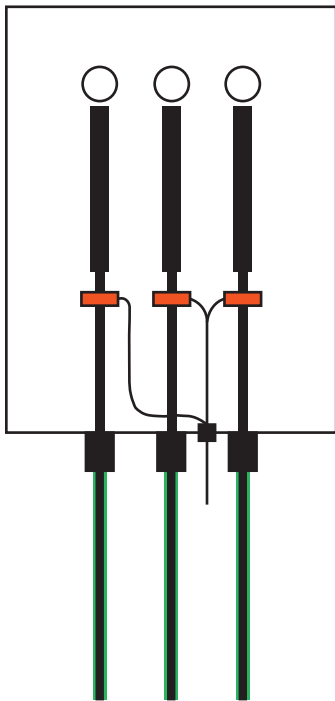
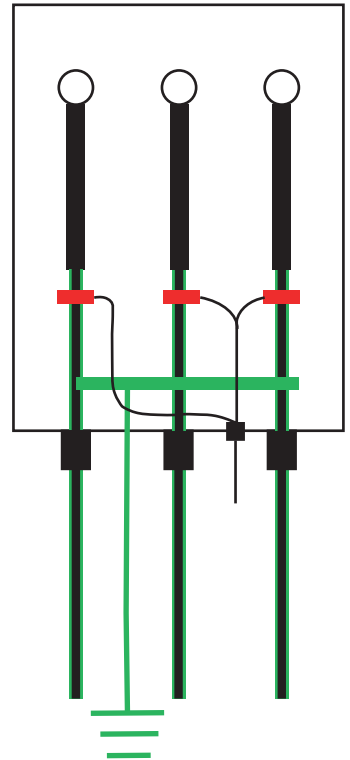

Fig 6.5

Individual phase C/T's may be installed and summated in parallel for earth fault output, or as a phase C/T's for over current and Earth Fault EFI. If the earth terminates below the C/T position then it will read pure fault current.

Band Current Transformer Outline

Phase C/Ts 50mm ID & Core Balance 120mm ID

Drawing 3

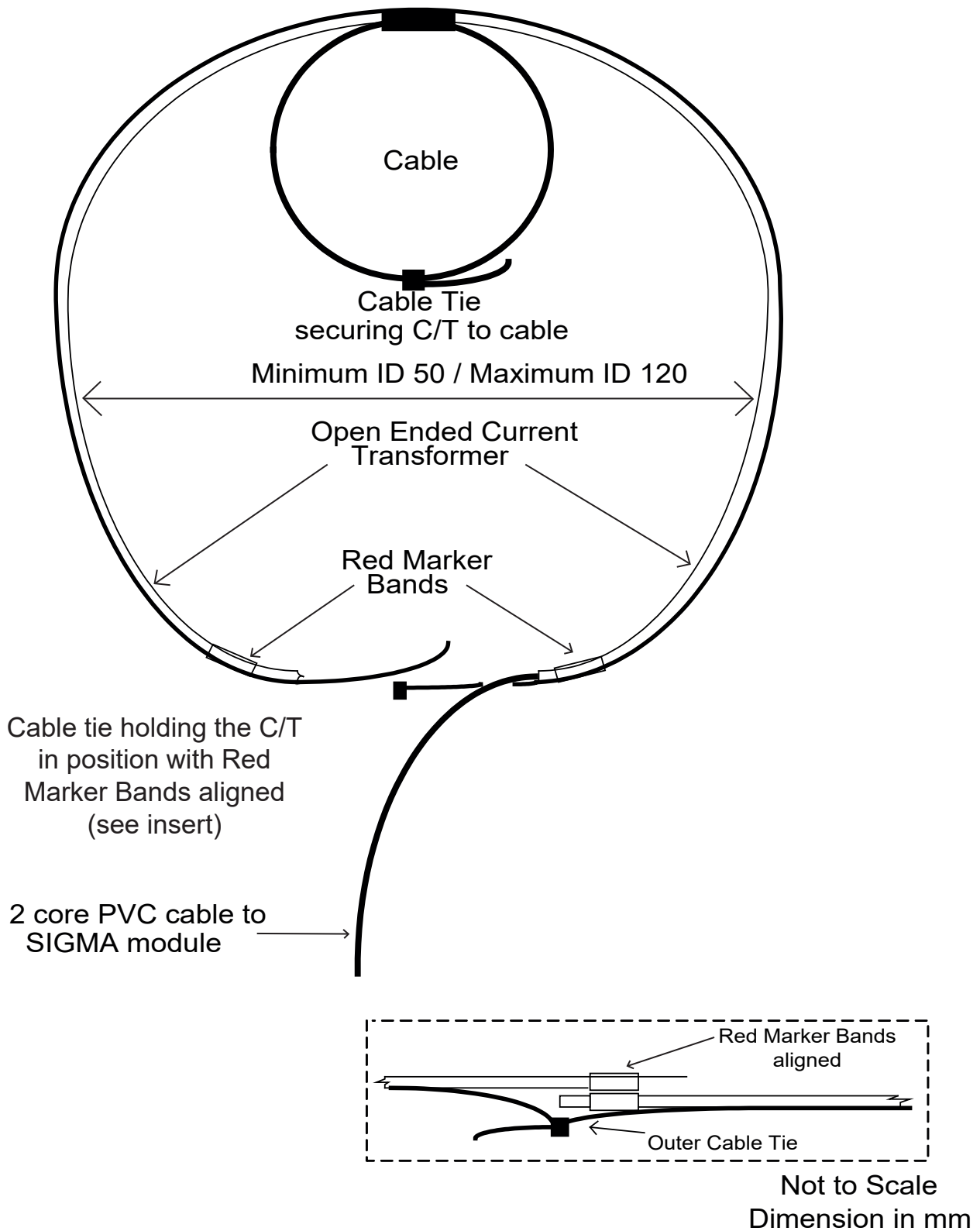

SIGMA Programmable Fault Passage Indicator Outline (Dimensions in mm & not to scale) Drawing 4

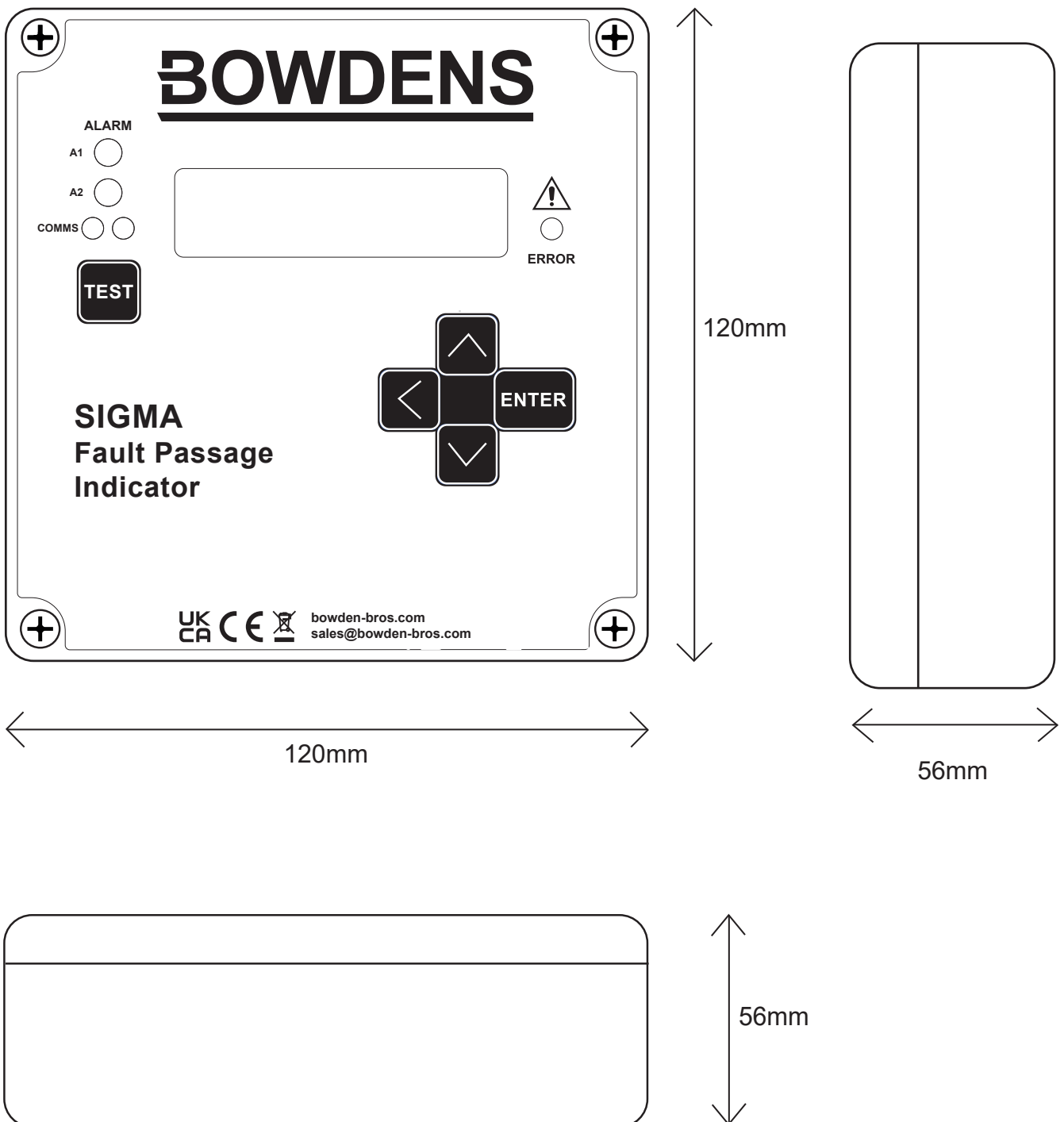

7.0 TYPE TESTING

Temperature Tests

IEC 60068 - Equipment fitted outdoors shall operate over the temperature range -20° C to + 80° C. The components and assemblies used in SIGMA modules meet this temperature requirement.

Shock Withstand Tests

IEC 60255-21-2 Shock Withstand:

A random selection of modules were tested. Slight abrasions were observed, however the polycarbonate did not chip or crack. A primary current test was carried out on each module after each test. The module was found to be unaffected by the mechanical vibration. After five tests each module was fitted to a Band Current Transformer and the complete assembly tested with a primary current. All tests were successful.

Environmental & Climatic Tests

IEC60068 - Modules have been left submerged continuously under a 300mm head of water. Modules are continually left in an outdoor exposed situation where the effects of weather and natural temperature cycling can be observed.

Electro-magnetic Compatibility Tests

Generic EMC Standards

BS EN 61000-6-4: 2001

BS EN55011:1998 + A1:1999

BS EN55011:1998 + A1:1999

-Generic emissions standard (Heavy industrial)

-Radiated Emissions.

-Conducted Emissions.

BS EN 61000-6-2: 2001

-Generic immunity standard (Heavy industrial)

BS EN 61000-4-2:1995 + A1 1998 + A2:2001

-Electrostatic discharge Immunity Test

BS EN 61000-4-3:2002 + A1:2002

-Radiated Immunity.

BS EN 61000-4-4:1995 + A1:2001+A2:2001

-Fast Transient/Bursts Immunity.

BS EN 61000-4-5:1995 +A2:2001

-Surge Immunity.

BS EN 61000-4-6: 1996 + A2:2001

-Conducted RF Immunity

BS EN 61000-4-8: 1996 + A2:2001

-Magnetic Immunity

Additional EMC Testing to meet power system environmental requirements

TEST 1 -BS EN 61000-4-8: 1994 50Hz Magnetic Field up to 6mT (5000A/m) continued stable for 3 seconds.

TEST 2 -BS EN 61000-4-11:1994 + A1:2001 - Voltage Dips and Interruptions

TEST 3 -BS EN 60255-5: 2001

8.0 SPECIFICATION DATA SIGMA all models

General Data

Module case	:	Polycarbonate material. Case to IP66 (dust and water jet proof)
Temperature range	:	-20° C to +80° C
Flag Indicator	:	2 x Ultra bright red LED flashing alternatively

Threshold Levels – User Settable

EF Trip Current	:	10 – 100A
OC Trip Current	:	100 – 1000A
Trip delay	:	30 - 150mS
Reset time	:	1 min - 24 hours
Accuracy	:	+/- 5A from any Bowdens C/T

Reset Options

Manual	:	Push Button
LV Reset Signal	:	Only available with power supply board
Timed Reset	:	1 min to 24 hours
Remote Reset	:	Via RTU Volts free relay signal

Alarm Mode

Permanent Faults	:	LEDs flash alternatively every four seconds
Transient Faults	:	LED gives two short flashes every three seconds for 24 hrs Occurs 15 secs after LV Reset

Enable/Disable Transient switch

After Ready Mode/Reset	:	Three flashes
Second Fault Alarm	:	Alert to second faults during Alarmed Mode
Power Source	:	Lithium battery 3.6V 16Ah. Battery Life 8 – 10 years.
Alarm Output Relay	:	Not supplied with Comms Option

9.0 MOUNTING DATA

SIGMA Fault Indicator Fixing Holes in Base

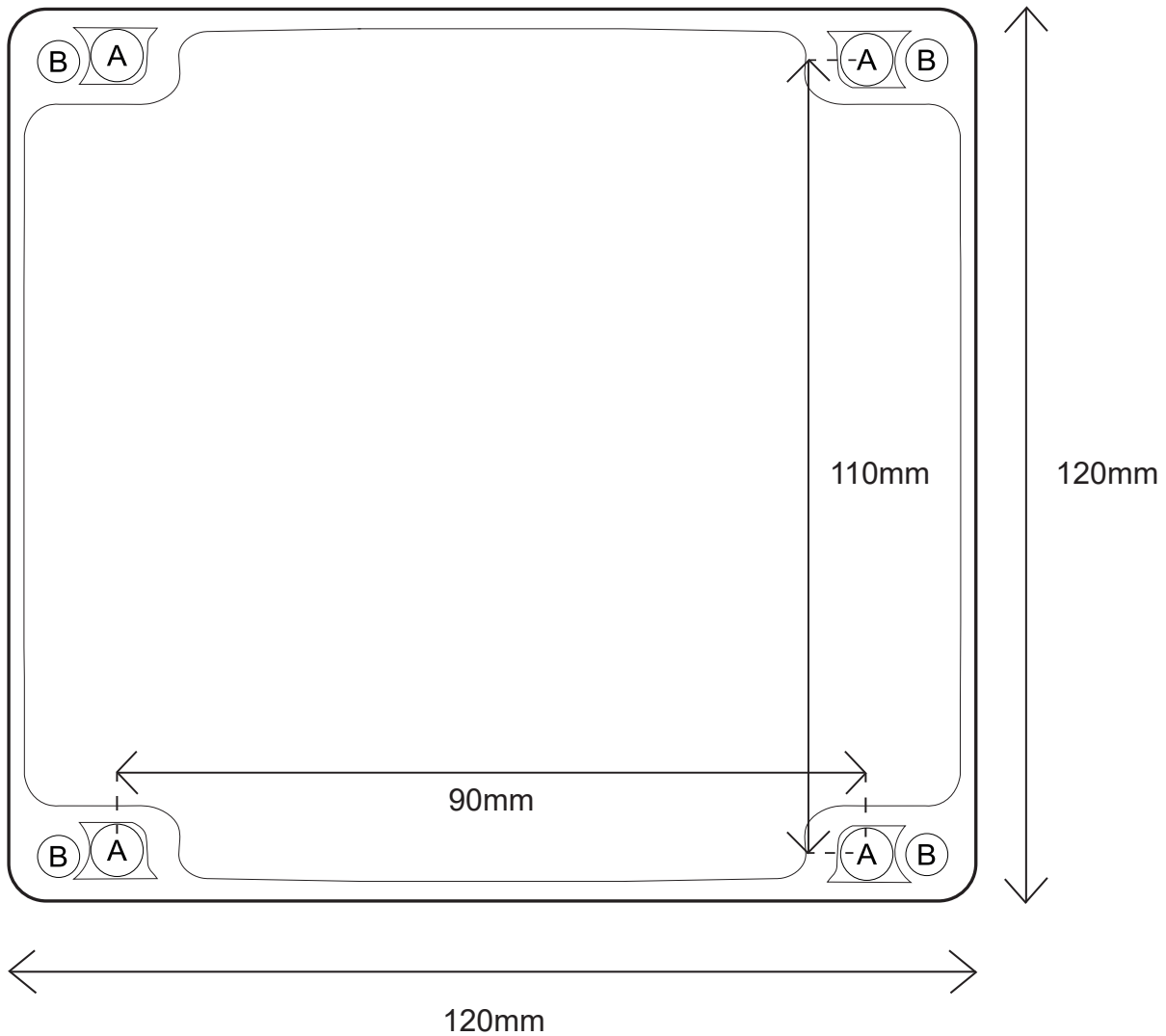

HOLES 'A' Corner fillet holes for fixing SIGMA base
 Holes 4mm diameter
 Distances between centres
 Dimensions in mm
 Not to scale

HOLES 'B' Recessed screw holes for securing SIGMA front panel



Please consider the environment at the end of this product's life.
 At end of life please take this unit to your closest electrical recycling point or return this unit to Spring (Europe) Limited for recycling.
 Recycle Responsibly
 ISO14001

VERSION 1.1
 RELEASE 09.09.25

ECO Reference	Date
ECO0371	08.09.25